

Panasonic®

Stereo Radio Cassette Player RQ-SX70V Operating Instructions



Before connecting, operating or adjusting this product, please read these instructions completely. Please save this manual.



Panasonic Consumer Electronics Company, Division of Matsushita Electric Corporation of America
One Panasonic Way Secaucus, New Jersey 07094
<http://www.panasonic.com>



Panasonic Sales Company, Division of Matsushita Electric of Puerto Rico, Inc. ("PSC")
Ave. 65 de Infanteria, Km. 9.5 San Gabriel Industrial Park, Carolina, Puerto Rico 00985

RQT4922-P
F0399E0(D)

Supplied Accessories

- ① Stereo headphones (RFEV711P-KS)
- ② Remote control (RFEV012P-KS)
- ③ Charger (RP-BC156APY)
- ④ Rechargeable battery (RP-BP61PYS1)
(In the carrying case (⑤))
- ⑤ Rechargeable battery carrying case (RFA0475-Q)
- ⑥ Dry cell battery case (RFA1136-H)
- ⑦ Carrying case (RFC0056-K)

•To order accessories contact 1-800-332-5368 or web site (<http://www.panasonic.com>).

•Use numbers indicated in parentheses when asking for replacement parts.

CAUTION:

This equipment has been tested and found to comply with the limits for a Class B digital device, pursuant to Part 15 of the FCC Rules.

These limits are designed to provide reasonable protection against harmful interference in a residential installation. This equipment generates, uses and can radiate radio frequency energy and, if not installed and used in accordance with the instructions, may cause harmful interference to radio communications. However, there is no guarantee that interference will not occur in a particular installation. If this equipment does cause harmful interference to radio or television reception, which can be determined by turning the equipment off and on, the user is encouraged to try to correct the interference by one of the following measures:

- Reorient or relocate the receiving antenna.
- Increase the separation between the equipment and receiver.
- Connect the equipment into an outlet on a circuit different from that to which the receiver is connected.
- Consult the dealer or an experienced radio/TV technician for help.

Any unauthorized changes or modifications to this equipment would void the user's authority to operate this device.

This device complies with Part 15 of the FCC Rules. Operation is subject to the following two conditions: (1) This device may not cause harmful interference, and (2) this device must accept any interference received, including interference that may cause undesired operation. The radio receiver is not subject to above item (2).

1

Prepare power supply.

You can operate the unit with one rechargeable battery (included) or one dry cell battery (not included).

To extend the playback time
Use both types of battery.

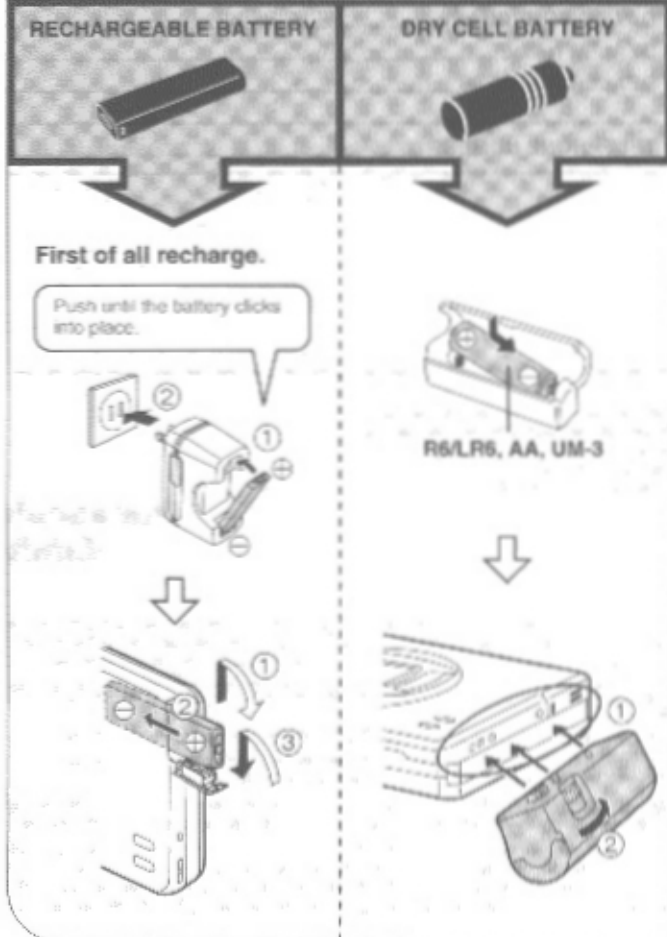

2

Connect the stereo headphones and the remote control.

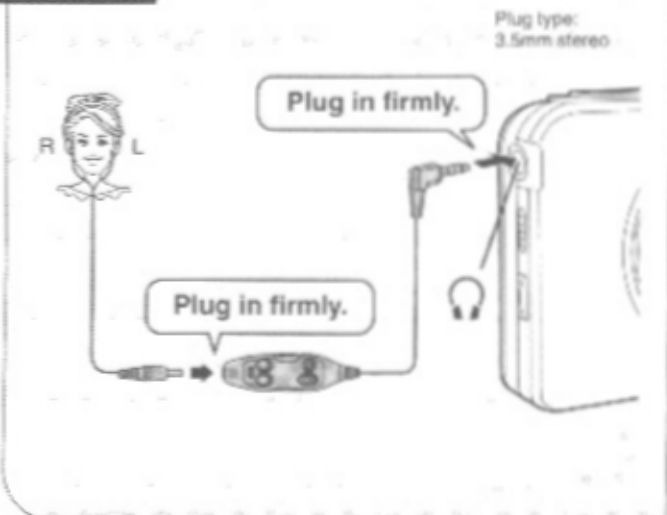

3

BATTERY CONDITION

SOUND SEL
In the stop mode **BATT**

Full Empty

CHANGING THE TONE

SOUND SEL
While playing a tape or radio **BATT**

" " (NORMAL)
"TRAIN" ← "S-XBS" ←

TAPE

1 Insert a tape.

Reverse side
Forward side

2 Release hold.

3 Press [▶].
(Power comes on and play starts.)

Playback side

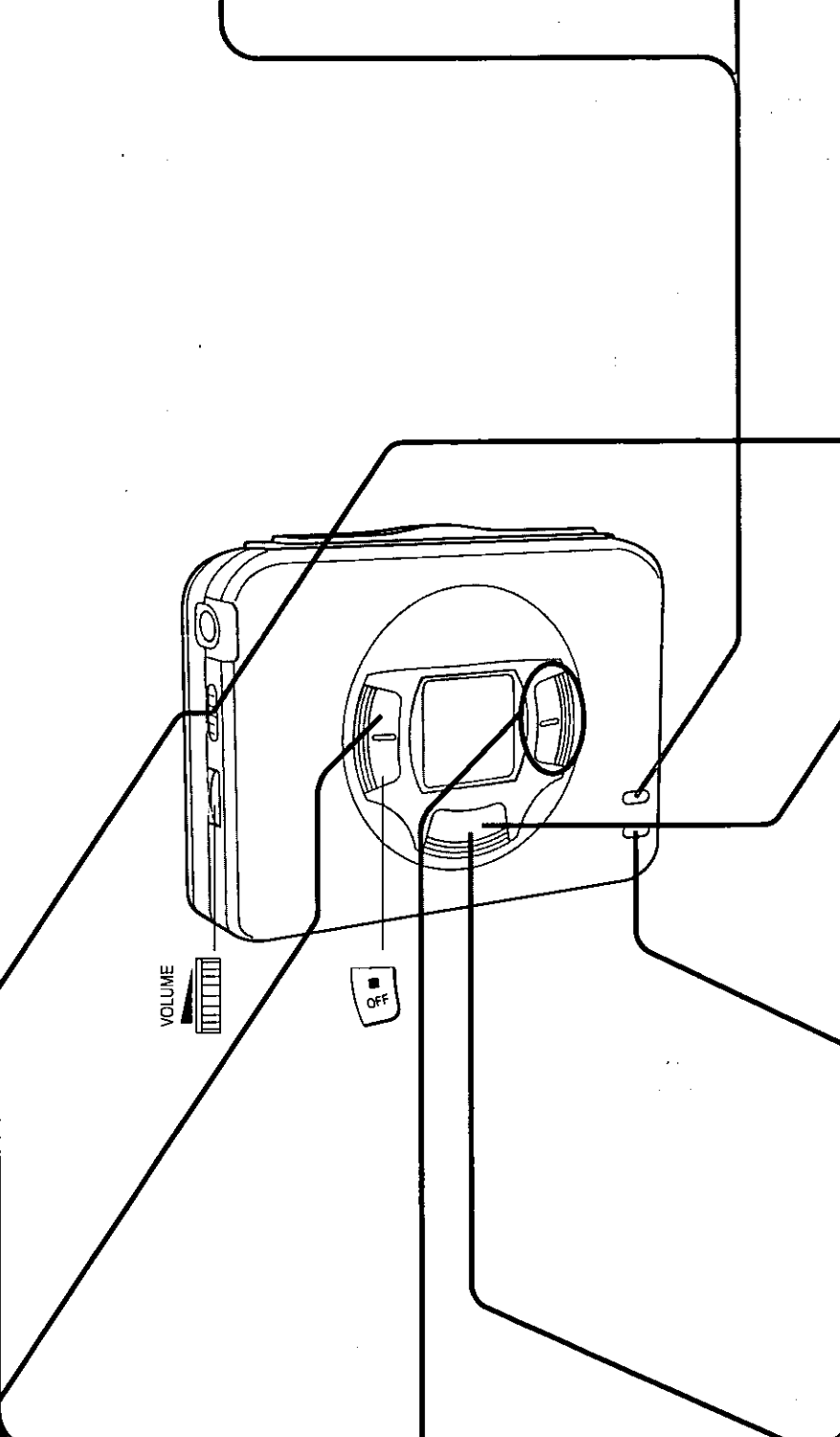

RADIO

1 Release hold.

2 Switch on the power.

3 Select the free mode.

TUNING MODE

AM
520

" " (Free mode*)
↑ ↓
"MEMO" (MEMO mode*)

* Free mode:
To listen to a desired station (not preset)
MEMO mode:
To listen to a preset station
(See page 8.)

Adjust the volume.

5 Select the station.







4 Select the band.

"AM"
↑ ↓
"FM"

Other play methods

TAPE PLAYBACK

The unit is equipped with an auto tape select function, so you can use normal, high or metal position tapes.

Function	Operation
Stop	During playback  Press.
Reverse tape direction	During playback  Press.
Fast forward (FF) or rewind (REW)*	In the stop mode   Press.
Tape Program Sensor (TPS)* You can skip as many programs as the number of times (up to 9) the button is pressed.	During playback   Press.
Listen to the tape recorded with Dolby B NR You can reduce noise to 1/3.	During playback  Press and hold. "DOLBY B NR ON" ↔ " " (OFF)

*The number of programs changes when the button is pressed while searching.

Dolby noise reduction manufactured under license from Dolby Laboratories Licensing Corporation. "DOLBY" and the double-D symbol are trademarks of Dolby Laboratories Licensing Corporation.

*To switch to playback during FF, REW or TPS: Press [◀▶].

RADIO RECEPTION

Function	Operation
Off	During reception  Press.

CHANGING THE TONE (Refer to the left illustration.)

NORMAL: Cancels the effect. Normal sound.

S-XBS: Boosts the low frequency range.

•If distortion occurs, turn down the volume.

TRAIN: Cuts down the audible level of sound which may disturb those around you.

How to use the remote control

Before operation, be sure to release hold.

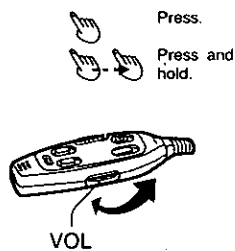
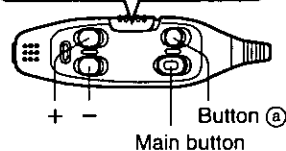

- Before using [VOL] on the remote control, adjust [VOLUME] on the main unit so the numbers "5-7" can be seen on the control.
- The operation tone, "beep", sounds whenever a remote control button is pressed. The beep tones, which are emitted when the main button is pressed, indicate that a cassette has not been inserted.

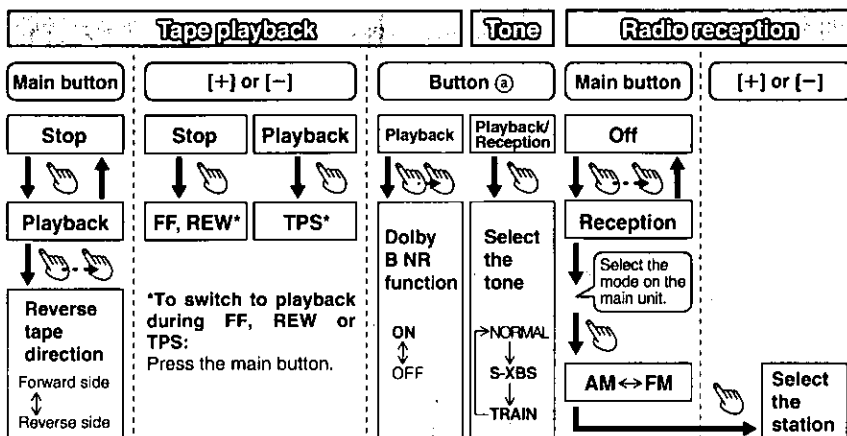

Troubleshooting Guide

Before requesting service for this unit, check the chart for a possible cause of the problem you are experiencing. Some simple checks or a minor adjustment on your part may eliminate the problem and restore proper operation.

If you are in doubt about some of the check points, or if the remedies indicated in the chart do not solve the problem, refer to the directory of Authorized Service Centers (enclosed with this unit) to locate a convenient service center, or consult your dealer for instructions.

For detailed instructions, contact an authorized service center 1-800-211-7262 or web site (<http://www.panasonic.com>).

BEFORE CALLING

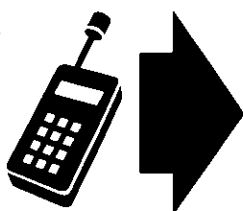

Symptom	Checkpoint
No operation possible.	Has the HOLD mode been released?
Remote control fails to work properly.	Have the headphones and remote control plugs been connected?
No sound is heard.	Are the plugs clean?
A cracking noise is heard.	Has the frequency step been set for your area?
•No reception. •The FM frequency range is different.	

HOLD



Hold function

This function prevents the unit from operating in error. Use this function to prevent the following situations:

A: While not in use, playback or radio reception starts inadvertently and the battery runs out.

B: Playback or radio reception is interrupted while the unit is in use.

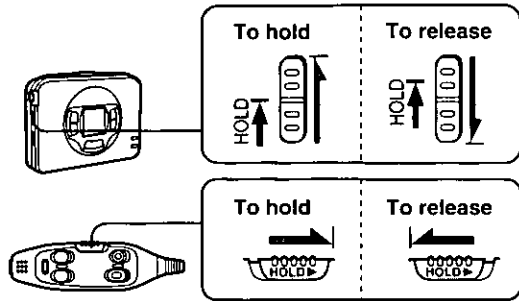

Before operation, be sure to release hold.

•The function on the main unit and the remote control are independent of each other.

As long as hold is on on the main unit

The key mark first flashes and then is displayed.

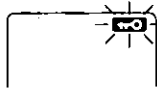

TAPE



When the cassette cover is closed

Tapeslack is wound automatically and playback will be ready to start from the forward side.

Auto-reverse

Unless manually stopped, the unit plays 3 sides of the tape and then automatically stops.

RADIO



To obtain better reception

AM:

Try various directions to obtain optimum reception.

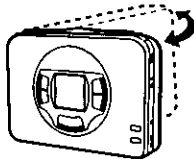

FM:

As the cord of the headphones acts as the FM antenna, extend it as far as possible rather than leaving it coiled.

To select stereo or monaural FM

Press and hold [SOUND SEL, BATT] (main unit) or the button (a) (remote control) during FM reception.

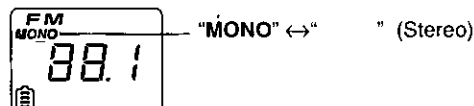
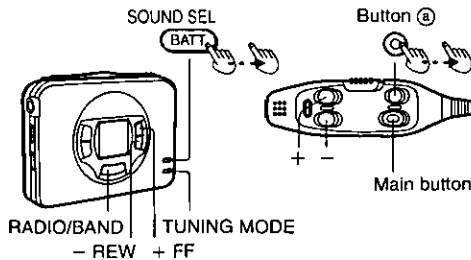

When there is noise during FM reception:

Select "MONO".

The sound becomes monaural, but noise is reduced.

RADIO



Preset tuning

Frequencies of up to 20 radio stations (10 each for AM and FM) can be stored in the memory.

Memory presetting

(Available only from the main unit)

Preparation: •Release hold.

•Connect the headphones (the cord of the headphones acts as an FM antenna) when storing frequencies of FM stations in the memory.

1. Press [RADIO/BAND] to switch on the power.
2. Press [TUNING MODE] to display "MEMO".
3. Press [RADIO/BAND] to select the band.
4. Press and hold [TUNING MODE] until the displayed frequency flashes.
5. Press [+ FF] or [- REW] to select the broadcast frequency.
6. Press [TUNING MODE] so that the memory number flashes.
7. Press [+ FF] or [- REW] to select the memory number to store the frequency.
8. Press [TUNING MODE].

To recall a preset station

1. Press [RADIO/BAND] (main unit) or press and hold the main button (remote control) to switch on the power.
2. Press [TUNING MODE] on the main unit to display "MEMO".
3. Press [RADIO/BAND] (main unit) or the main button (remote control) to select the band.
4. Press [+] or [-] to select the desired station.

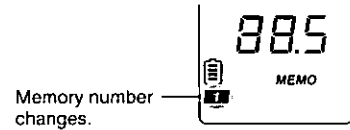

To erase an unnecessary station from the memory

(Available only from the main unit)

1. Press [RADIO/BAND] to switch on the power.
2. Press [TUNING MODE] to display "MEMO".
3. Press [RADIO/BAND] to select the band.
4. Press [+ FF] or [- REW] to select the memory number to be removed.
5. Press and hold [TUNING MODE] until the displayed frequency flashes.
6. Press and hold [TUNING MODE] until "----" flashes.
7. Press [TUNING MODE].

When using overseas

(Available only from the main unit)

The allocation settings according to the area are needed.

1. Press [RADIO/BAND] to switch on the power.
2. Press [RADIO/BAND] for more than 5 seconds to display the step.
3. Press [+ FF] or [- REW] to select the step. Each press changes the indication to "FM U0.2", "FM U0.1" or "E".

"FM U0.2" (original setting):

FM 0.2 MHz,
AM 10 kHz

"FM U0.1": FM 0.1 MHz,
AM 10 kHz

"E": FM 0.05 MHz,
AM 9 kHz.

4. Press and hold [TUNING MODE] until the frequency is displayed to confirm the step.

To return to the previously frequency step:

Repeat the steps above.

Note:

Converting the allocation erases the stations previously stored in memory.

BATTERY



■ Rechargeable battery

For initial use after purchase or after a long interval (more than three months), be sure to recharge the rechargeable battery.

A full charge, which takes about 2 hours, enables you to enjoy about 17 hours of tape playback or about 13 hours of radio reception (at 25°C).

- The included rechargeable battery can be recharged about 300 times. When its operation time becomes extremely shortened, that's time for replacing it.

■ Battery condition indicators

The indicators are shown whenever a tape is travelling or the radio is on.

- The indicators may show a lower amount of charge during some operations.

To confirm the indicators in the stop mode

Press [SOUND SEL, BATT].

When the battery becomes weak

The indicators will flash.

Recharge the rechargeable battery or replace the dry cell battery with a new one.

MAINTENANCE



Main unit

Clean the cabinet with a cloth, dampened in mild solution of soap and water. Do not use benzine or thinner or aerosol type cleaner.

Head care

To ensure good sound quality, clean the head after approximately every 10 hours of use with a cotton swab dampened with a little alcohol.

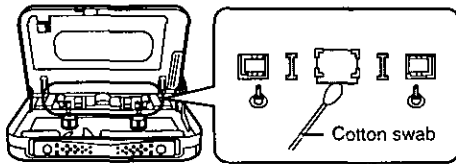

CAUTION



- Avoid using or placing this unit near sources of heat. Do not leave it in an automobile exposed to direct sunlight for a long period of time with the doors and windows closed.
- To avoid product damage, do not expose this product to rain, water or other liquids.

When recharging

- Use only the included charger.
- It is normal for the charger and the rechargeable battery to become slightly warm.
- Do not leave the charger turned on for more than 12 hours at one time, otherwise the rechargeable battery life may be shortened.

About rechargeable battery and dry cell battery

- Align the poles (+ and -) properly when inserting the battery.
- Do not apply heat to batteries, or internal shortcircuit may occur.
- Remove all the batteries if the unit is not to be used for a long time.
- Remove spent batteries immediately.
- Carry and store the rechargeable battery in the supplied battery carrying case to prevent contact with metal objects.
- Do not peel off the plastic covering on the rechargeable battery. This covering has been fitted for your safety and removal can lead to short-circuiting of the battery.
- Do not recharge ordinary dry cell battery.

Mishandling of battery can cause electrolyte leakage which can damage items the fluid contacts and may cause a fire.

If electrolyte leaks from the battery, consult your dealer.

Wash thoroughly with water if electrolyte comes in contact with any part of your body.

The product you have purchased is powered by a nickel-cadmium battery which is recyclable. Please call 1-800-8-BATTERY for information on how to recycle this battery.



CAUTION



■ Listening caution



Do not play your headphones or earphones at a high volume. Hearing experts advise against continuous extended play.

If you experience a ringing in your ears, reduce volume or discontinue use.

Do not use while operating a motorized vehicle. It may create a traffic hazard and is illegal in many areas.

You should use extreme caution or temporarily discontinue use in potentially hazardous situations.

Even if your headphones or earphones is an open-air type designed to let you hear outside sounds, don't turn up the volume so high that you can't hear what's around you.

Sound can be deceiving. Over time your hearing "comfort level" adapts to higher volumes of sound. So what sounds "normal" can actually be loud and harmful to your hearing.

Guard against this by setting your equipment at a safe level BEFORE your hearing adapts.

To establish a safe level:

- Start your volume control at a low setting.
- Slowly increase the sound until you can hear it comfortably and clearly, and without distortion.

Once you have established a comfortable sound level:

- Set the dial and leave it there.

Specifications

■ RADIO

Frequency range:	FM: 87.9-107.9 MHz (0.2 MHz steps) 87.5-108.0 MHz (0.1 MHz/0.05 MHz steps)
	AM: 520-1710 kHz (10 kHz steps) 522-1629 kHz (9 kHz steps)

■ CASSETTE PLAYER

Track system:	4 track, 2 channel, stereo
Frequency range (Normal/High/Metal):	40-18000 Hz

■ GENERAL

Output jack:	HEADPHONES; 20Ω
Rechargeable Battery;	DC 1.2 V (included rechargeable battery)
Battery;	DC 1.5 V (one R6/LR6, AA, UM-3 battery)
Dimensions (W×H×D):	108.8×78.5×20.7 mm (4 3/16"×3 1/8"×1 3/16")
Weight (with rechargeable battery):	174 g (6.1 oz.)

■ CHARGER

Input:	AC 120 V, 60 Hz
Output:	DC 350 mA, 1.2 V

Play time:

[Approximate operating time in hours (in hold mode, at 25°C, on a flat, stable surface).]

Battery type	Tape	Radio
Rechargeable*	17	13
Panasonic alkaline	57	45
Both together*	72	56

- * When the included rechargeable battery is fully recharged (2 hours required).
- The play time may be less depending on the operating conditions.

Note

Specifications are subject to change without notice. Weight and dimensions are approximate.

Product Service

Do not attempt to remove the cover(s) or repair the unit yourself. Refer servicing to qualified personnel only.

■ Product information

For product service, product information or assistance with product operation, refer to the servicenter directory.

User memo:

DATE OF PURCHASE _____
DEALER NAME _____
DEALER ADDRESS _____

TELEPHONE NUMBER _____

The serial number of this product can be found on the back of the cassette compartment cover or inside the battery compartment. Please note it in the space provided below and keep as a permanent record of your purchase to aid identification in the event of theft.

MODEL NUMBER _____ **RQ-SX70V** _____
SERIAL NUMBER _____

Panasonic Consumer Electronics Company,
Division of Matsushita Electric Corporation of
America
One Panasonic Way,
Secaucus, New Jersey 07094

Panasonic Sales Company, Division of
Matsushita Electric of Puerto Rico, Inc. ("PSC")
Ave. 65 de Infantería, Km. 9.5
San Gabriel Industrial Park
Carolina, Puerto Rico 00985
Tel. (809) 750-4300
FAX. (809) 768-2910

Panasonic Audio Products Limited Warranty

Panasonic Consumer Electronics Company or Panasonic Sales Company (collectively referred to as "The warrantor") will repair this product with new or refurbished parts, free of charge, in the U.S.A. or Puerto Rico from the date of original purchase in the event of a defect in materials or workmanship as follows:

AUDIO COMPONENTS, RADIOS, COMPACT DISC PLAYERS, VIDEO CD PLAYERS AND HOME ENTERTAINMENT SYSTEMS—For one (1) year.

ACCESSORIES, HEADPHONES AND CARTRIDGES—(when applicable) For ninety (90) days.

BATTERIES—(when applicable)—New rechargeable batteries in exchange for defective rechargeable batteries—For ten (10) days. Non-rechargeable batteries are not warranted.

RECHARGEABLE BATTERY PACKS—(when applicable)—New rechargeable battery packs in exchange for defective rechargeable battery packs for (90) days. Non-rechargeable battery packs are not warranted.

Carry-in or mail-in service in the continental U.S.A. can be obtained during the warranty period from a Panasonic Services Company (PASC) Factory Servicenter listed in the Servicenter Directory. Or call 1-800-211-7262, toll free, to locate an authorized PASC Servicenter. Carry-in or mail-in service in Puerto Rico can be obtained during the warranty period by calling the telephone numbers listed in the Servicenter Directory.

This warranty is extended only to the original purchaser. A purchase receipt or other proof of date of original purchase will be required before warranty service is rendered.

This warranty only covers failures due to defects in materials or workmanship which occur during normal use and does not cover normal wear to the stylus (when applicable) or dealer installed cartridge or stylus. It does not cover damage which occurs in shipment of failures which are caused by products not supplied by the

warrantor or failures which result from accident, misuse, abuse, neglect, mishandling, misapplication, faulty installation, set-up adjustment, improper maintenance, alteration, improper antenna, inadequate signal pick-up, maladjustment of consumer controls, modification, or commercial use of product, or service by anyone other than a PASC Factory Servicenter or authorized PASC Servicenter, or damage that is attributable to acts of God.

LIMITS AND EXCLUSIONS

There are no express warranties except as listed above.

THE WARRANTOR SHALL NOT BE LIABLE FOR INCIDENTAL OR CONSEQUENTIAL DAMAGES RESULTING FROM THE USE OF THIS PRODUCT, OR ARISING OUT OF ANY BREACH OF THIS WARRANTY, INCLUDING WITHOUT LIMITATION, DAMAGE TO TAPES RECORDS OR DISCS. ALL EXPRESS AND IMPLIED WARRANTIES INCLUDING THE WARRANTIES OF MERCHANTABILITY AND FITNESS FOR A PARTICULAR PURPOSE, ARE LIMITED TO THE APPLICABLE WARRANTY PERIOD SET FORTH ABOVE. Some states do not allow the exclusions or limitation of incidental or consequential damages, or limitations on how long an implied warranty lasts, so the above exclusions or limitations may not apply to you.

This warranty gives you specific legal rights and you may also have other rights which vary from state to state.

If a problem with this product develops during or after the warranty period, you may contact your dealer or Servicenter. If the problem is not handled to your satisfaction, then write to the Consumer Affairs Division at the company address indicated above.

If you ship the product

Carefully pack and send it prepaid, adequately insured and preferably in the original carton. Attach a postage-affixed letter, detailing the complaint, to the outside of the carton.

Do NOT send the product to the Executive or Regional Sales offices. They are NOT equipped to make repairs.

Customer's Record

Model No. _____

Dealer's Name _____

Serial No. _____

or

Code No. _____

Dealer's Address _____

Date of Purchase _____
